

# 0230-1 + 15

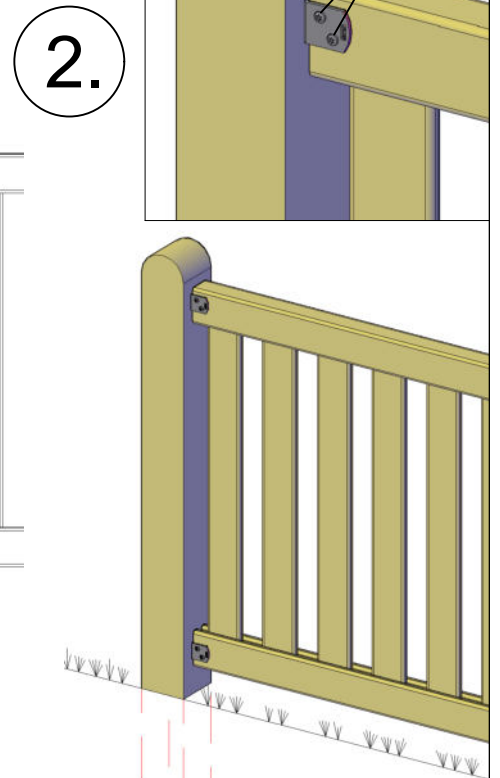

# 0230-1 + 15

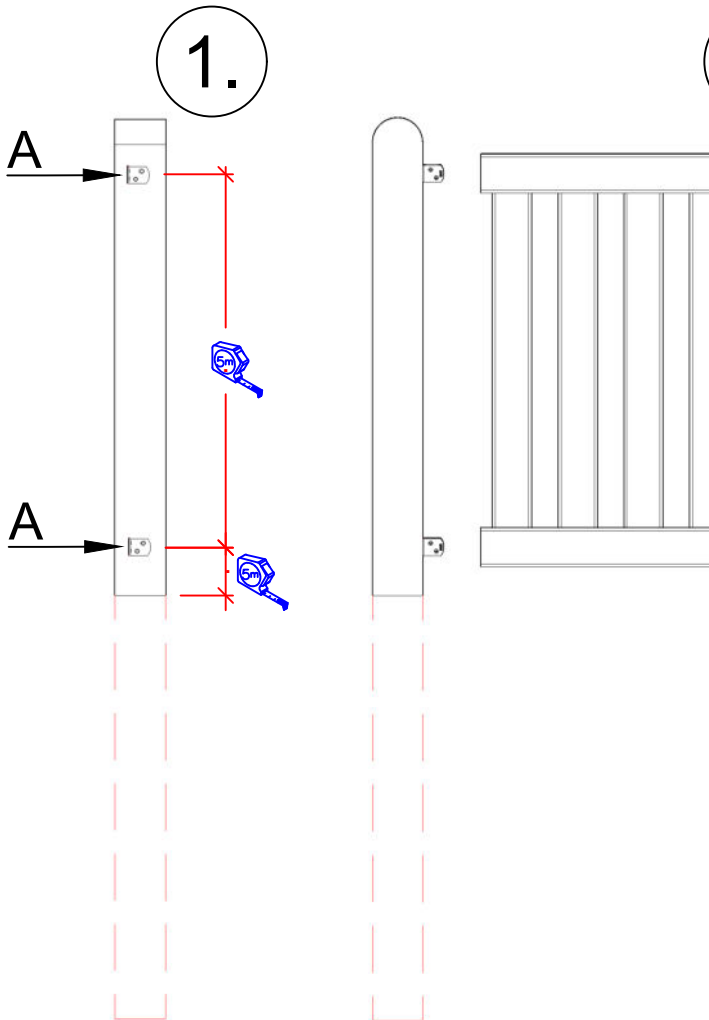
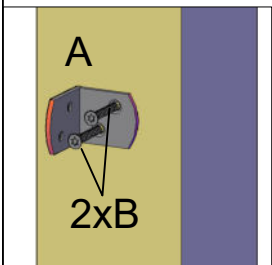
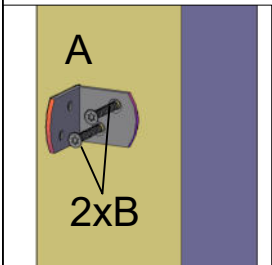
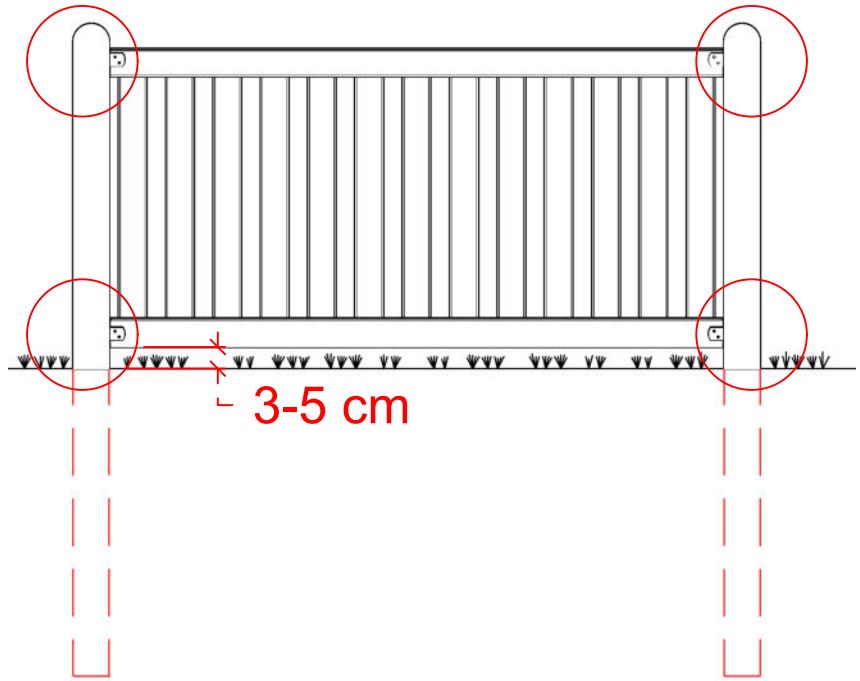
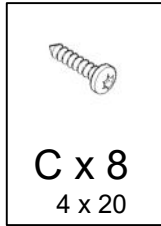
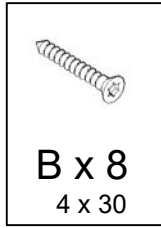
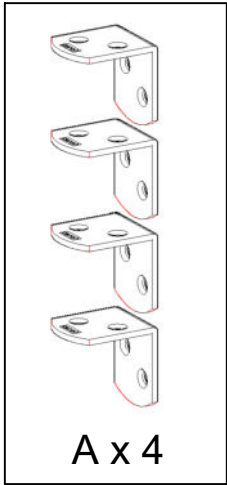
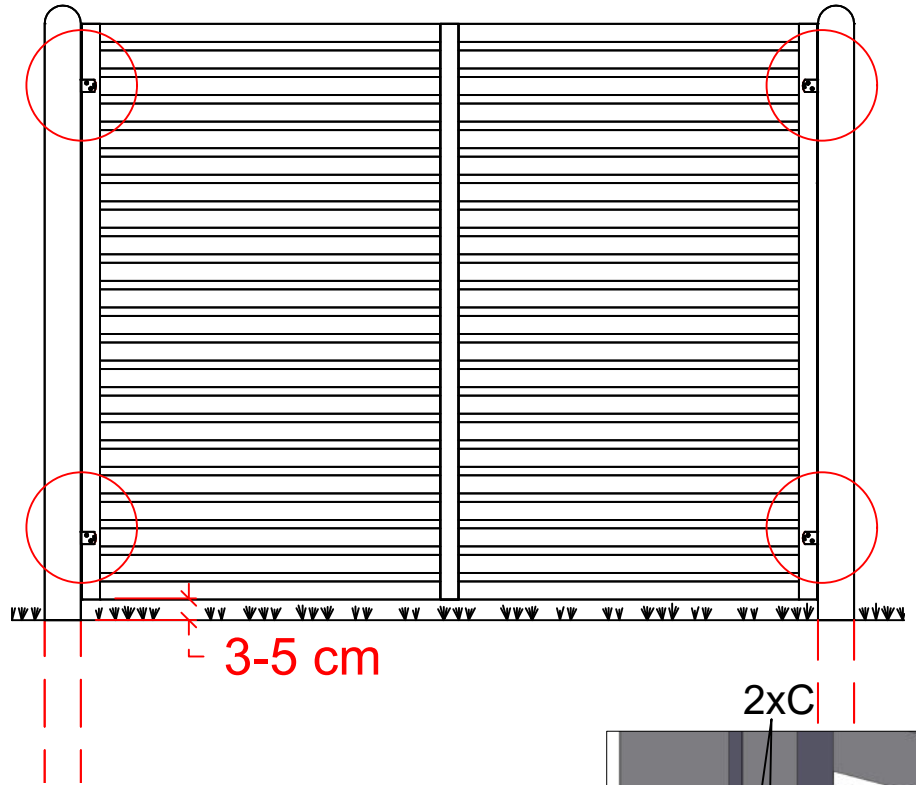
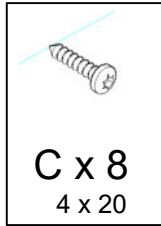
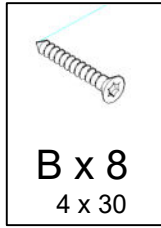
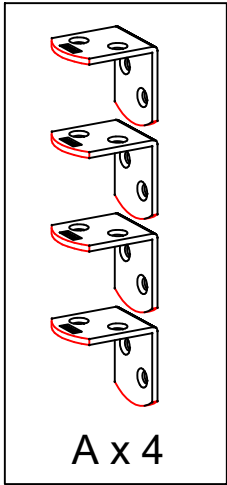

1.

2.

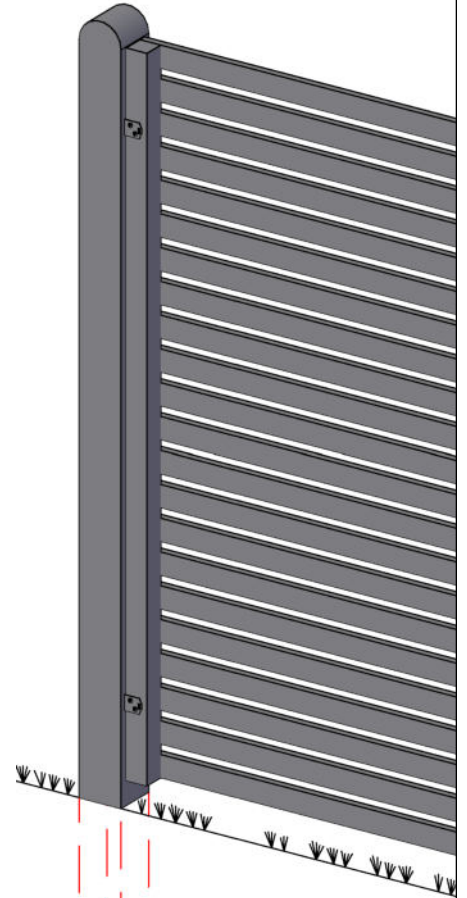
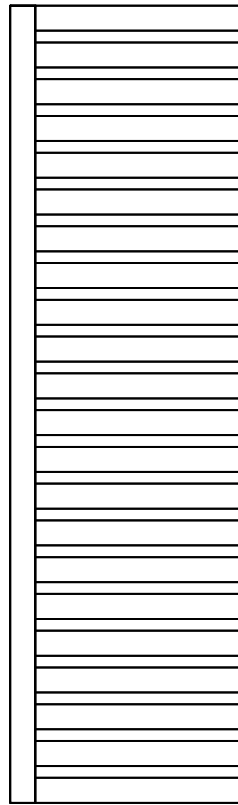
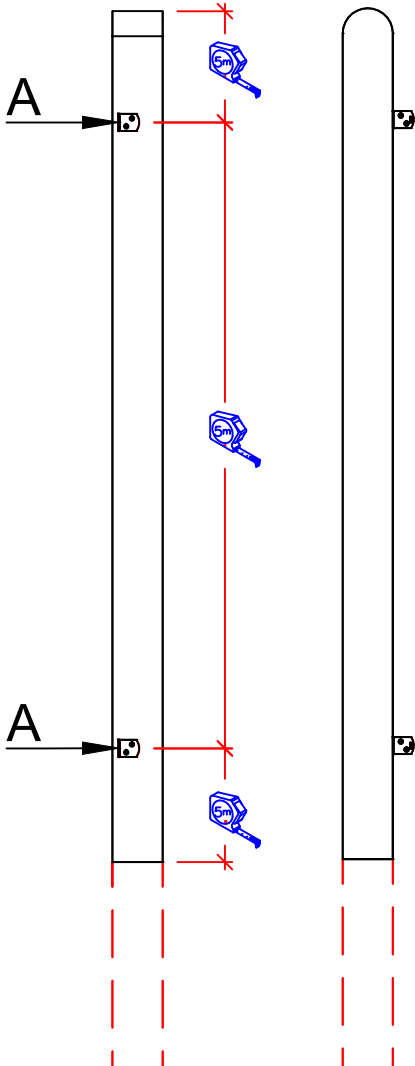
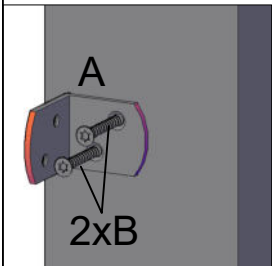
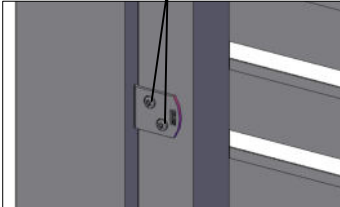

# 0230-1 + 15

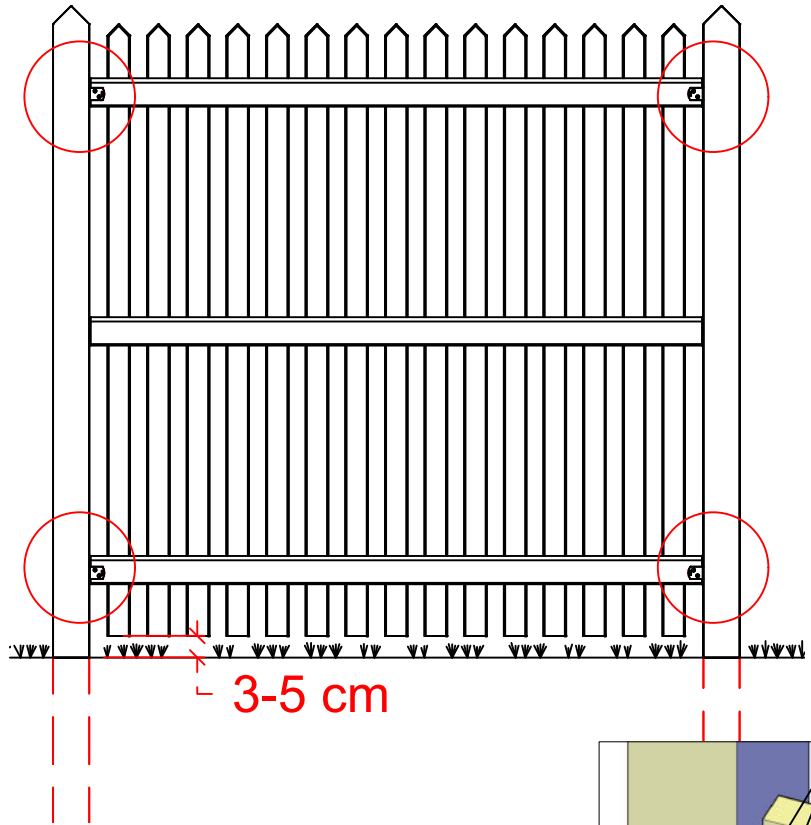
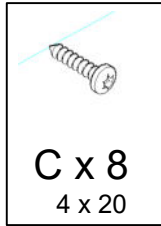
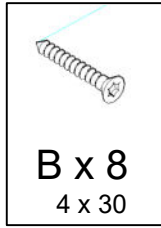
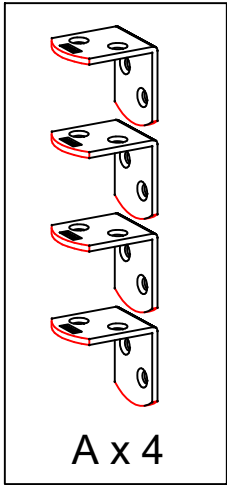

1.

2.

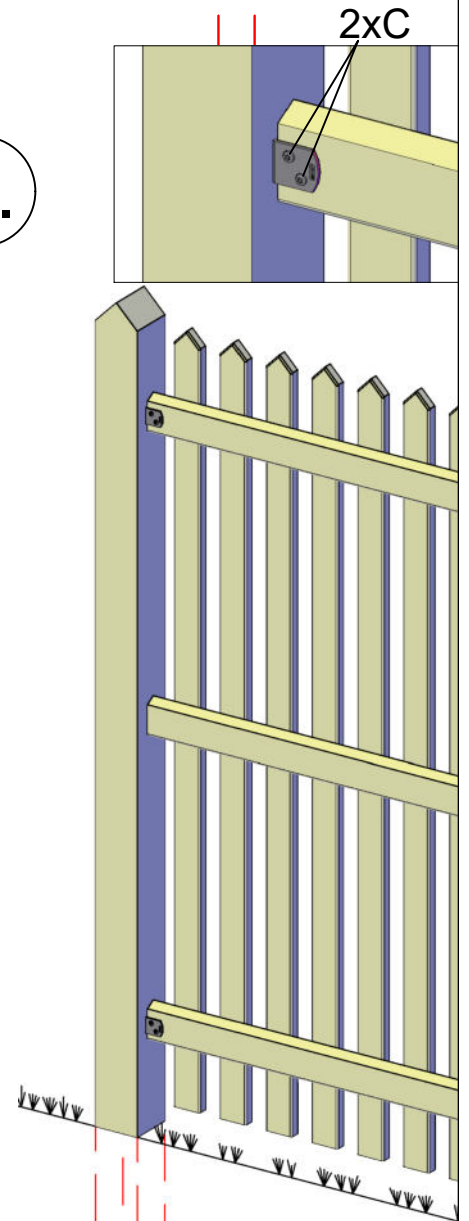
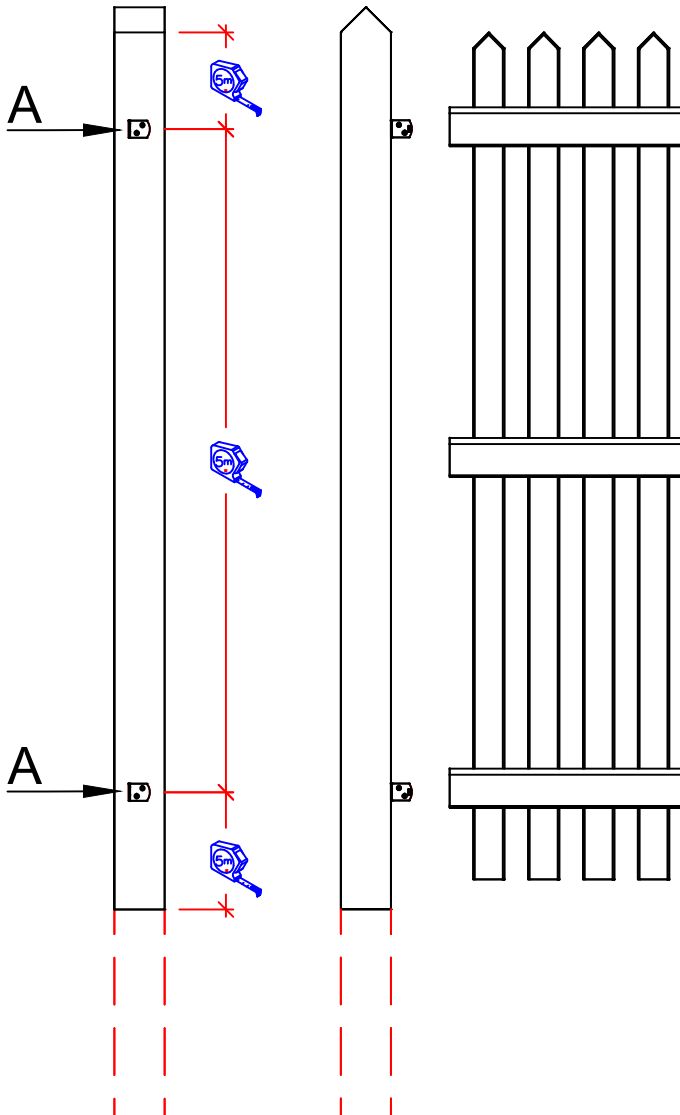
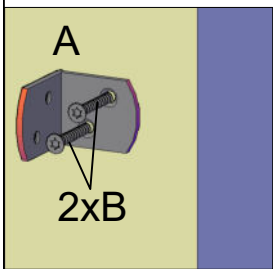
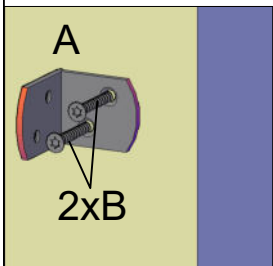

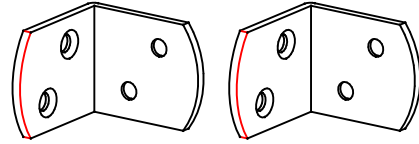

## **Tips:**

Hegnene kan monteres på husmuren, men det kræver at muren er helt lige.

Desuden anbefaler vi at der skrues i mursten - ikke i fugen.

Brug rawplugs og skruer, der passer til det pågældende murværk - spørg i byggemarkedet.

## **Tipp:**

Die Holz Zäune können auch an der Hausmauer befestigt werden, aber nur wenn die Mauer auch ganz gerade ist.

Des Weiteren empfehlen wir, dass die Beschläge nicht in der Fuge sondern im Ziegelstein festgeschraubt werden.

Verwenden Sie Dübel und Schrauben, die für das jeweilige Mauerwerk geeignet sind - fragen Sie evtl. im Fachhandel oder Baumarkt nach.

## **Tips:**

The wood Fence can be mounted on the house wall, but it requires the wall to be completely straight.

In addition, we recommend that the screws are screwed into bricks - not in the joint.

Use rawplugs and screws that fit the particular masonry - ask in the construction market.

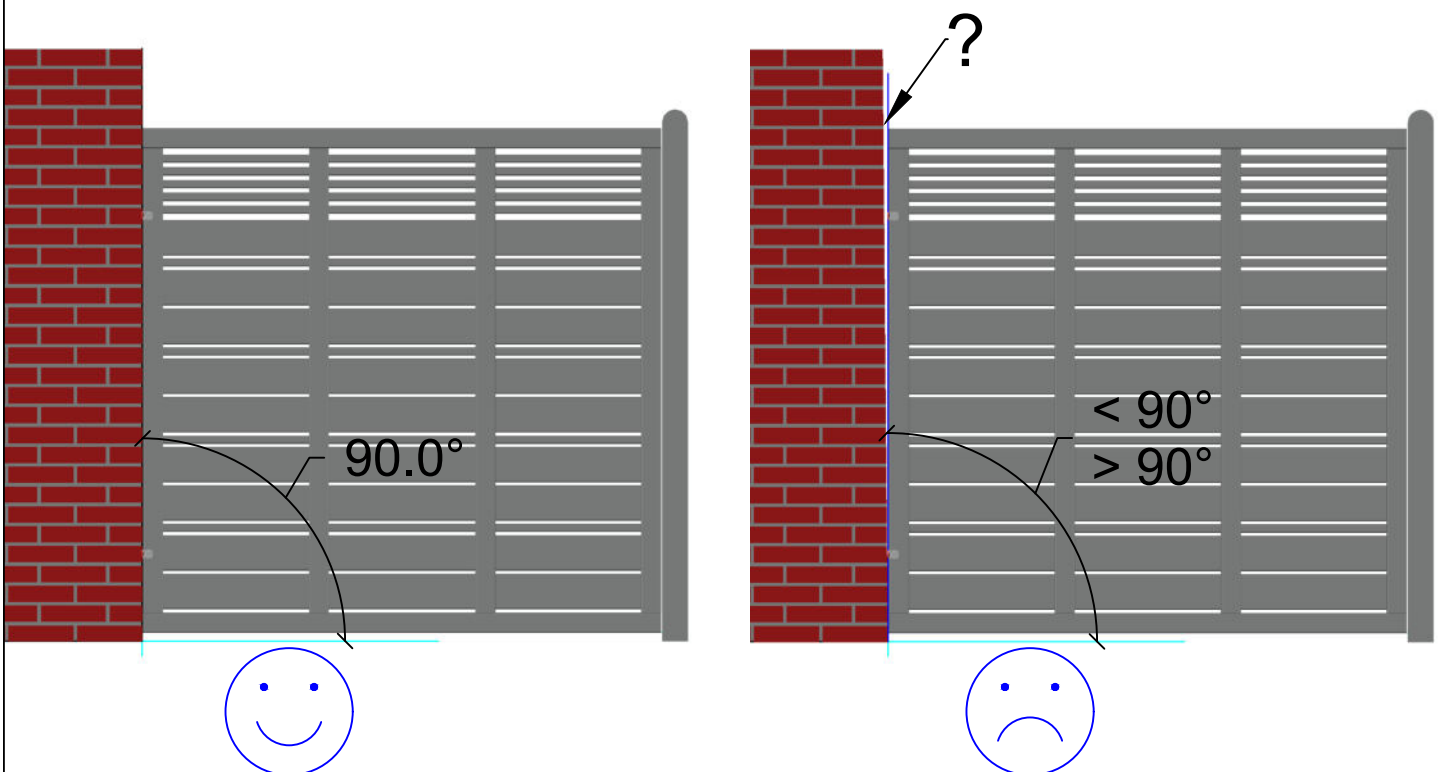
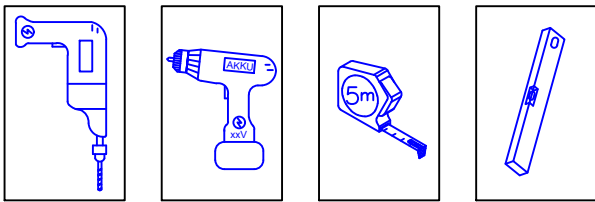

1.

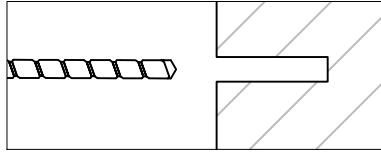

2.

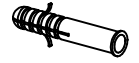
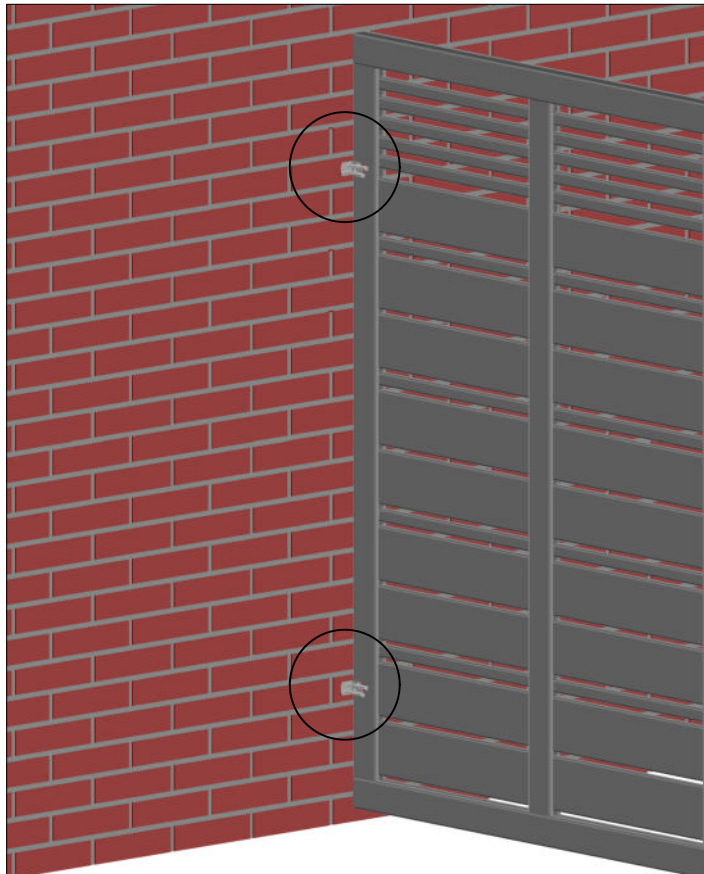
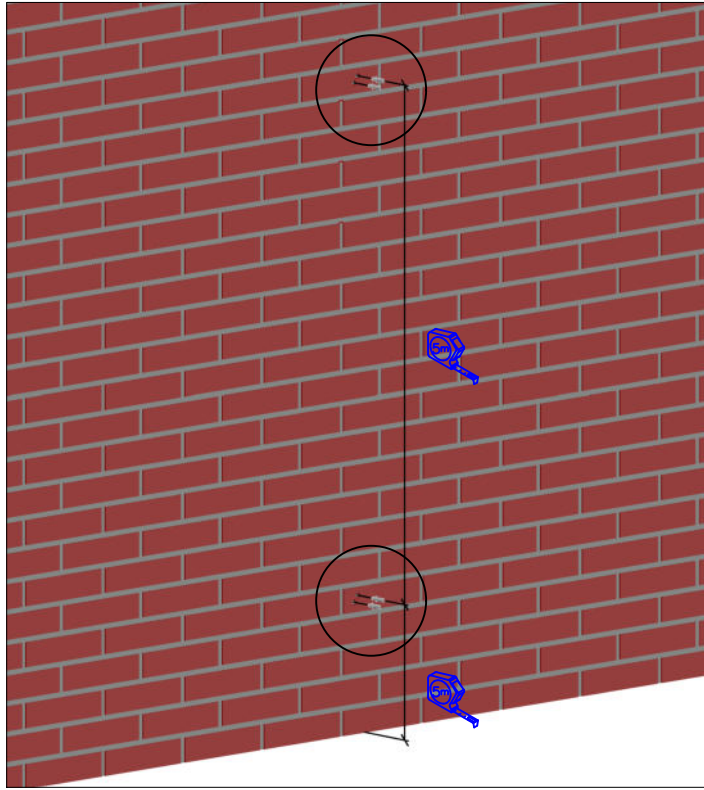
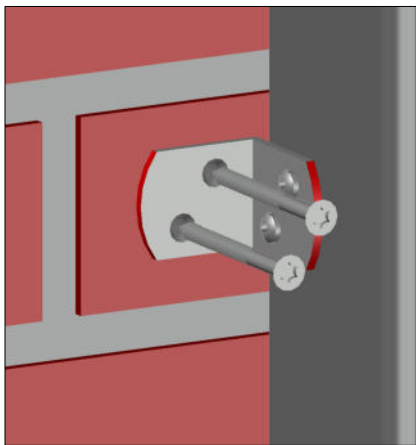
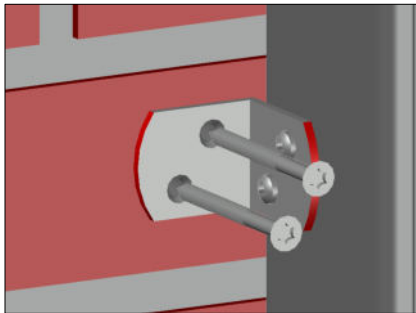
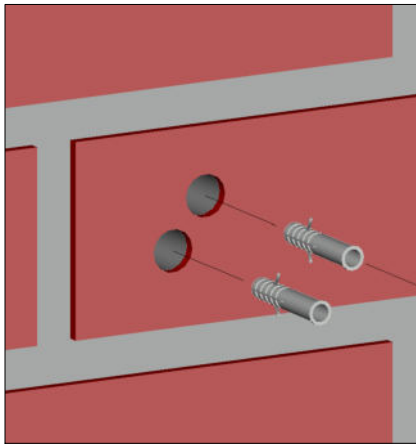
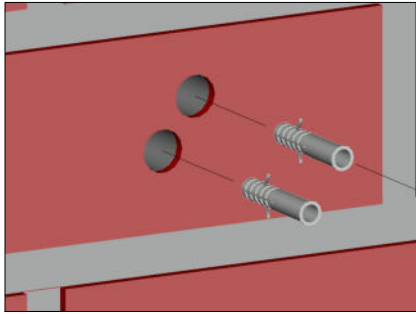
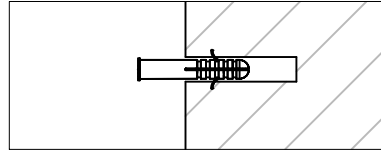

A x 4

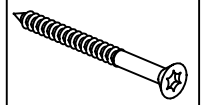

B x 4

